



COURTSIDER® XL



by LSI Courtsider Sports Lighting

COURTSIDER XL — BRINGS EXCELLENCE TO TENNIS COURT LIGHTING

The Courtsider XL, a sharp cutoff luminaire, was specifically designed to meet the unique needs of tennis court lighting.

To provide a comfortable environment for the tennis player, the Courtsider XL luminaire's Forward Throw reflector system projects light only onto the court area,

unlike "flood" style fixtures which create glare and can adversely affect the player's performance. The clean profile of the Courtsider XL lighting assembly complements the design of today's tennis facilities and the choice of colors allows the lighting system to blend easily into the tennis court

surroundings.

Resorts, country clubs, apartment and condominium complexes, hotels and private residences are typical installations for the Courtsider XL...the tennis court fixture with distinctive styling and lighting control excellence.



FEATURES

Pole and Fixture Placement

Installing the fixtures courtside removes the light source from the player's normal line of vision. This placement provides excellent illumination both on the court and on the tennis ball.

Fixture

The Courtsider XL's Forward Throw Reflector and concealed light source provide a sharp cutoff which successfully prevents unwanted glare. Its 1000 watt Metal Halide lamp source promotes efficiency and longer life. This successful combination eliminates costly maintenance work and keeps the court in a playable night-time condition. Energy saving 875 watt and 750 watt pulse-start metal halide versions are also available.

Fixture Mounting Height

A fixture mounting height of 22' (20' pole) provides the optimum balance of uniform court illumination and spill light containment. For increased uniformity of lighting on the court and improved lob shot illumination, fixture mounting heights of up to 30' are available. Higher mounting heights will result in a slightly increased amount of spill light.

Quantity of Light

The proper amount of light is important in the design of tennis court lighting and is typically dependent of what level of play is being performed. LSI Courtsider Sports Lighting has identified various levels of play and accordingly, appropriate light levels. Each system uses

the proper number of fixtures and pole locations to reach these levels.

Uniformity of Light

Uniform light distribution is crucial when addressing the ratio of the maximum level on the court to the minimum level. LSI Courtsider Sports Lighting recommends that this maximum to minimum comparison be under a 2:1 ratio. By conforming to this criteria, a comfortable lighting system is insured.

Customized Footcandle Chart

A computerized footcandle chart, illustrating the Courtsider XL at work in your specific project, is available for the asking. Contact LSI Courtsider Sports Lighting for more details.

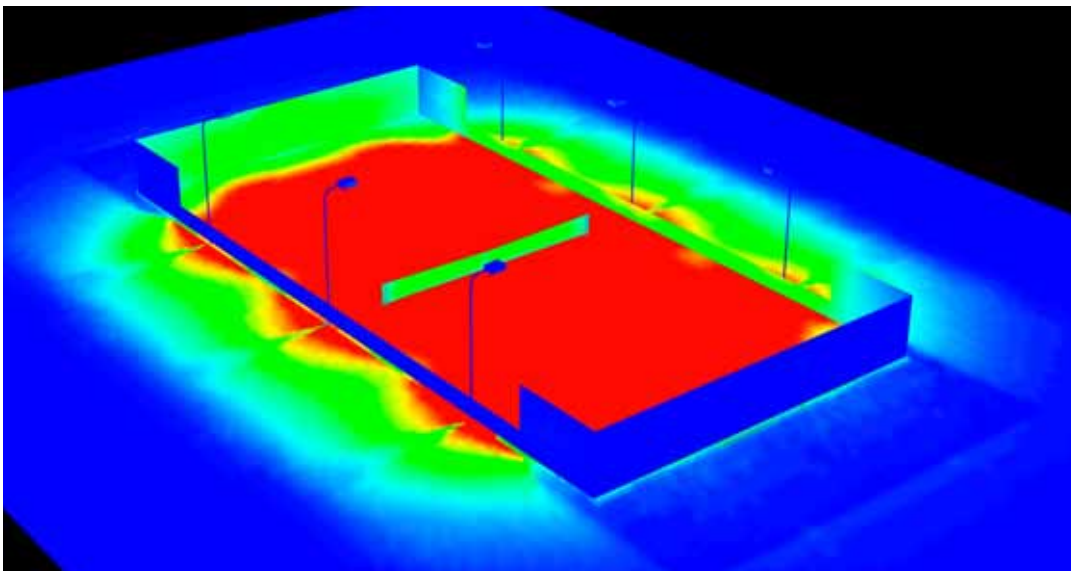

Radiosity analysis showing lighting intensity on and off the court

STANDARD LAYOUTS

Layout #1
Recreational

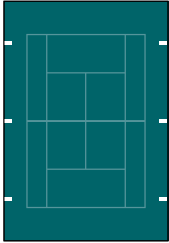

(6) CXLS-A Assemblies

Layout #2
Recreational

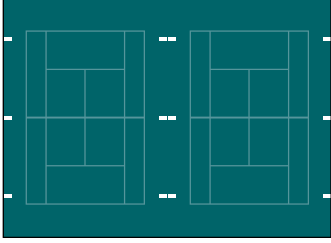

(6) CXLS-A Assemblies
(3) CXLS-B Assemblies

Layout #3
Club/Tournament

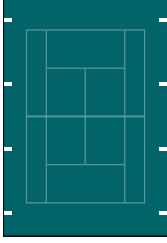

(8) CXLS-A Assemblies

Layout #4
Club/Tournament

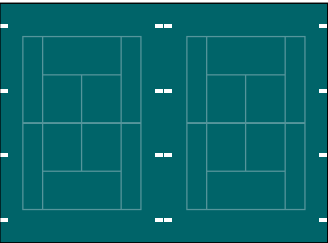

(8) CXLS-A Assemblies
(4) CXLS-B Assemblies

Layout #5
Narrow Court
Recreational

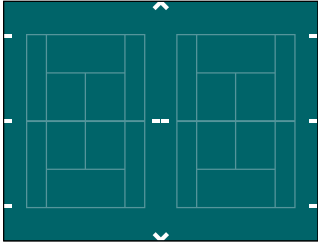

(6) CXLS-A Assemblies
(1) CXLS-B Assemblies
(2) CXLS-C Assemblies

Layout #6
Narrow Court
Club/Tournament

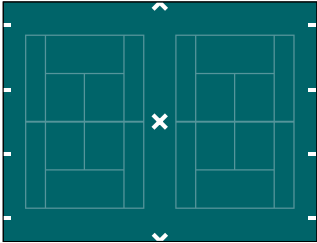

(8) CXLS-A Assemblies
(2) CXLS-C Assemblies
(1) CXLS-D Assemblies

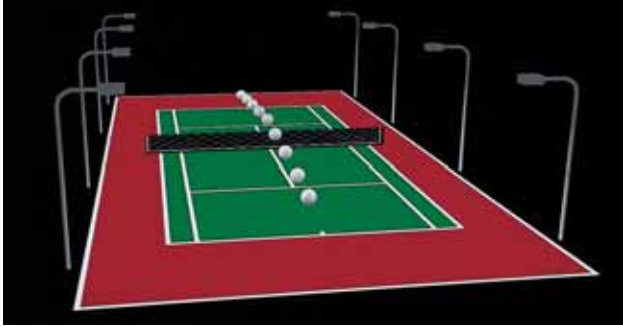

A properly designed tennis lighting system should do more than light the surface of the court. More importantly, the system should effectively light the **tennis ball** in its flight path across the court. The proper quantity and location of poles and fixtures will insure this objective is achieved.

CONFIGURATIONS

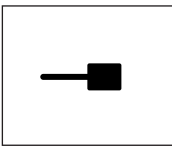

Single
CXLS-A Assemblies

- (1) Courtsider XL Fixture
- (1) Single Upsweep Bracket
- (1) Round Steel Pole

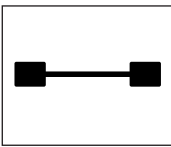

D180
CXLS-B Assemblies

- (2) Courtsider XL Fixtures
- (1) Twin 180° Upsweep Bracket
- (1) Round Steel Pole

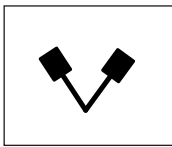

D70
CXLS-C Assemblies

- (2) Courtsider XL Fixtures
- (1) Twin 70° Upsweep Bracket
- (1) Round Steel Pole

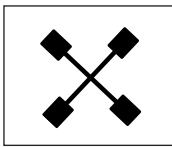

Q90
CXLS-D Assemblies

- (4) Courtsider XL Fixtures
- (1) Quad Upsweep Bracket
- (1) Round Steel Pole

FEATURES

The one-piece aluminum housing features square corners which are welded to produce a clean edge while increasing housing strength and ensuring weather-tight construction. One-piece construction eliminates the worry of moisture entering from poorly sealed top pans and side panels.

The Courtsider XL offers a Forward Throw (FT) reflector system designed specifically for perimeter lighting applications to eliminate stray light and produce a sharp backside cutoff.

The Courtsider XL is available in 6 standard finishes which will match any court environment. DuraGrip®, LSI Courtsider Sports Lighting's revolutionary superior baked-on polyester-powder finishing process, gives the fixture an exceptionally attractive appearance. This unique polyester protection lets the fixture withstand extreme weather changes without cracking or peeling. Finish is guaranteed for five full years.

The Courtsider XL is designed to utilize a 1000 watt Metal Halide lamp. Energy saving 875 watt and 750 watt pulse-start metal halide versions are also available.

Porcelain sockets feature spring-reinforced contacts for long life.

Four inch diameter bracket slipfits 4" or 5" diameter poles for a smooth transition. Hardware to level the bracket is internally threaded, concealing it from view for a cleaner appearance.

Clear flat tempered glass lens.

Continuous one-piece EPDM gasket for maximum sealing.

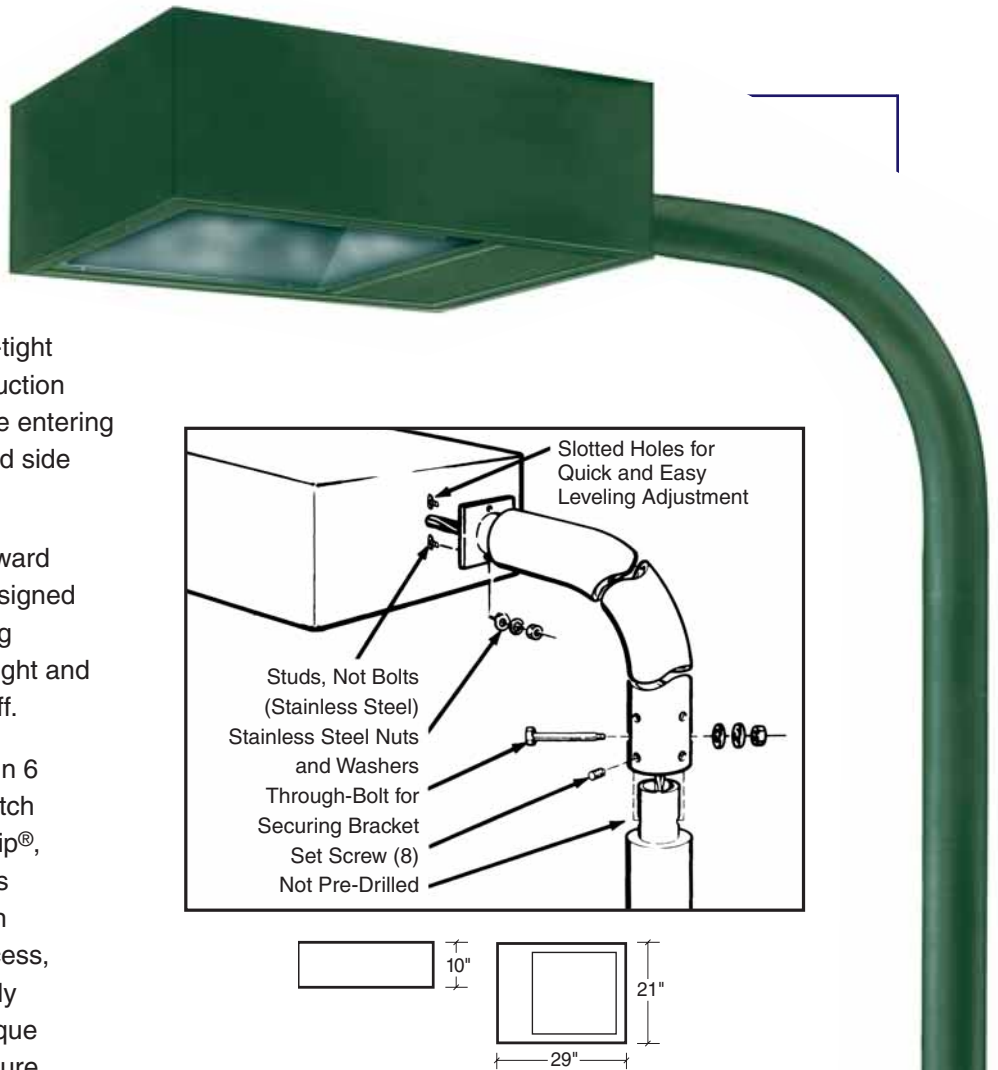

LSI Courtsider Sports Lighting is committed to providing community-friendly lighting that delivers high quality, energy efficient illumination while eliminating unnecessary uplight and minimizing light trespass. The Courtsider XL is considered to be community-friendly, meeting IESNA's full cutoff classification.

LSI – a smart energy solution

POLE AND BRACKET SPECIFICATION

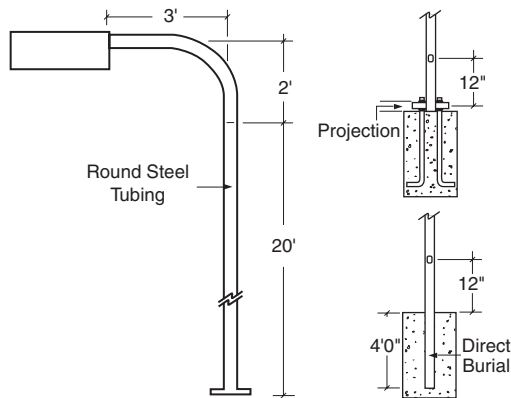

POLES (Straight Round Steel Poles)

- Pole shafts are electro-welded ASTM-A513 round steel tubing.
- Tenon is 2-3/8" O.D. high strength pipe. Tenon is 4-3/4" in length.
- Poles are furnished with Galvanized anchor bolts. Anchor bolts conform with ASTM-A36 with a minimum yield strength of 36,000 PSI.
- Base is ASTM-A36 hot-rolled steel plate with a minimum yield strength of 36,000 PSI.
- 3" x 6" oval hand-hole is 12" above pole base.
- Ground lug is standard.
- Ground fault circuit interrupter is optional.
- Four-inch diameter bracket slipfits pole tenon. Hardware to level the bracket is internally threaded, concealing it from view for a cleaner appearance. One through-bolt secures bracket.
- 4" O.D. 10 Ga. steel tubing is approximately 6 lbs. per ft.
- 5" O.D. 11 Ga. steel tubing is approximately 7 lbs. per ft.
- 5" O.D. 07 Ga. steel tubing is approximately 10 lbs. per ft.
- Two-piece fabricated aluminum base cover is standard for anchor base poles.

ORDERING CHART

Assembly Type	Luminaire Wattage	Luminaire Voltage	Pole Type	Pole Height*	Pole Material	Assembly Finish
CXLS-A (single)	1000 - 1000 Watt	MT - Multi Tap ¹	AB -Anchor Base ³	18	410 - 4" o.d. 10 Ga. Steel ⁵	BLK - Black
CXLS-B (twin 180°)	Metal Halide	480V	DB - Direct Burial	20	511 - 5" o.d. 11 Ga. Steel	GRN - Green
CXLS-C (twin 70°)	875 - 875 Watt Pulse-Start Metal Halide	220/240V 50HZ ²		22	507 - 5" o.d. 7 Ga. Steel ⁶	BRZ - Bronze
CXLS-D (quad)	750 - 750 Watt Pulse-Start Metal Halide			24		PLP - Platinum Plus
				26		BUF - Buff
				28		WHT - White
						GPT - Graphite
						MSV - Metallic Silver

EXAMPLE OF A TYPICAL ORDER **CXLS-A - 1000 - MT - AB - 20 - 410 - BLK**

Luminaire Options	Pole Options
HSS - House Side Shield ⁷ PLS - Polycarbonate Shield ⁸	GFI - Weatherproof Duplex Receptacle w/ GFCI protection ⁹ LAB - Less Anchor Bolts

- 1 - MT (multi-tap ballasts include taps for 120V, 208V, 240V, or 277V)
- 2 - For international applications where 50hz power is standard (e.g. Europe & Asia).
- 3 - All anchor base assemblies are supplied with galvanized anchor bolts and base covers.
- 4 - For anchor base assemblies, the heights shown are the pole length. The fixture mounting height will be 2' higher than the pole height using the upsweep bracket (e.g. with a 20' pole the fixture mounting height is 22'). For direct burial assemblies, the height shown is the above grade section. Direct burial poles will also include a 4' below grade section (e.g. a 20' direct burial pole is 24' overall length). Direct burial poles are limited to maximum 24' above grade height.
- 5 - 4" poles are available only up to 22' height.
- 6 - The quad assembly (CXLS-D) is only available with a 5" o.d., 7 gauge pole.
- 7 - Under normal use, the Courtsider XL fixture produces acceptable light cutoff. For highly sensitive applications, the optional external rear cutoff shield is available.
- 8 - Use only for high vandalism areas. This add-on shield will discolor over time due to UV exposure from the metal halide lamp.
- 9 - The GFI receptacle installs in the standard handhole location 12" above the pole base.



FINISHES



Black



Green



Bronze



Platinum Plus

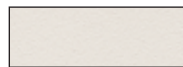

Buff



White



Graphite



Metallic Silver



LSI Courtsider Sports Lighting
10000 Alliance Road, Cincinnati, Ohio 45242
Phone: (800) 794-3448 • Fax: (800) 373-9998
E-mail: courtsider@lsi-industries.com • www.courtsider.com

A Company with a Smart Vision



© 2007 LSI Industries Inc.
3268 9/07 5K